



CC-Link

Open Field Network

Cable Wiring Manual



This documentation describes items to consider in advance, how to select devices, points to keep in mind and procedure in order to set up cable wiring.

Abstract of contents

Chapter 1: Procedure for cable wiring of network system

Chapter 2: Construction and specifications of network system

Chapter 3: Select guide for connected devices

Chapter 4: Set up and cable wiring

We hope that every customer sets up CC-Link system easily by reading this documentation.

If you have any questions about this documentation, please don't hesitate to contact CLPA, which is written on last page of this documentation.

CC-Link Partner Association (CLPA)

Revisions

Revision item	Revision description	Revision date	Sub number
2: Construction and specifications of network system	· Note 1 was added to 1) in (1) CC-Link versions. · Tables 2.3, 2.4, 2.5, and 2.6 were modified in (2) Multidrop connection (CC-Link Ver.1.10).	March 2024	H

Contents

Chapter 1: Procedure for cable wiring of network system	1
Chapter 2: Construction and specifications of network system	3
2.1 Abstract of network construction	4
2.2 Network specification	6
Chapter 3: Select guide for connected devices	12
3.1 CC-Link Cable	13
3.2 Terminal resistor	14
3.3 Connector	15
3.4 Power supply	17
Chapter 4: Set up and cable wiring	18
4.1 Points to keep in mind to set up cable wiring	19
4.2 Process and connection of CC-Link dedicated cable (In case of terminal)	21
4.3 Terminal resistor connection	23
4.4 Connection of shield line with ground	24
Appendix CC-Link Ver.1.00 Specifications	27

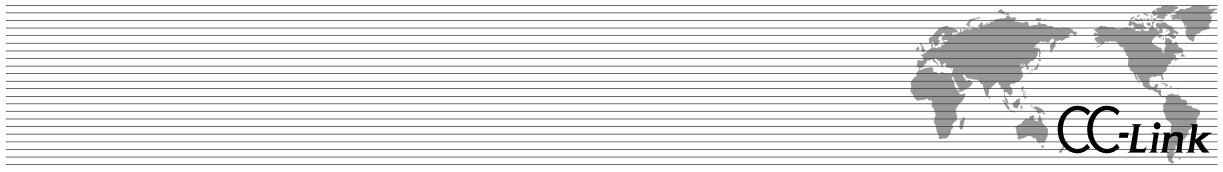

Chapter 1: Procedure for cable wiring of network system

CC-Link

Chapter 1: Procedure for cable wiring of network system

Procedure for cable wiring of CC-Link network system is as following:

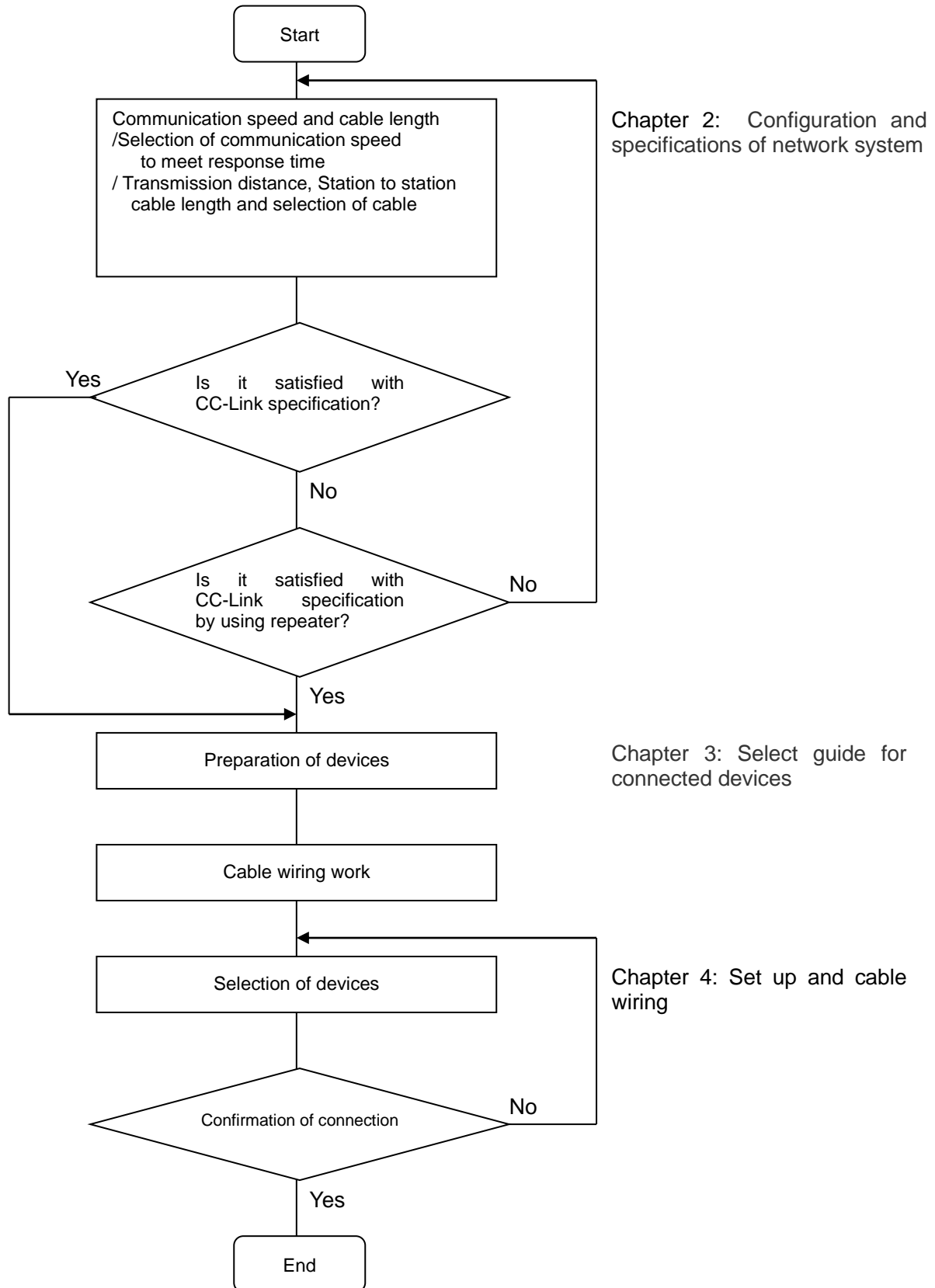
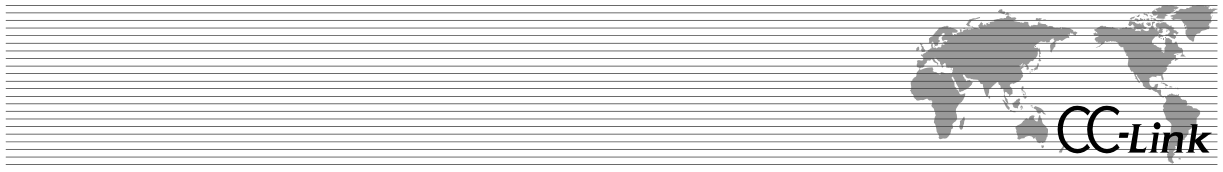

Fig. 1.1 Procedure for cable wiring of CC-Link network system



Chapter 2: Construction and specifications of network system

CC-Link

Chapter 2: Construction and specifications of network system

2.1 Abstract of network configuration

Explanation of terminology and definitions of abbreviations

Station:

A device that is connected via the CC-Link to which any of station numbers 0 to 64 can be assigned.

Master station

A station that has the control information (parameters) and controls the entire network. One master station is required in each network. The station number is fixed to 0.

Local station

A station that can perform n:n cyclic transmission and transient transmission with the master station and other local stations.

Remote station

A generic term for stations other than a master station and local station

Standby master station

A station that replaces the master station to continue the data link in case the master station function stops. A standby master station has the same functions as those of the master station, and functions as a local station in a normal condition.

Intelligent device station

A station that can perform 1:n cyclic transmission and transient transmission with the master station.

Remote device station

A station that can use bit data and word data.

Remote I/O station

A station that can only use bit data.

Cable: Use CC-Link dedicated cable (Shielded, 3-core twisted pair cable)

Terminal resistor: The resistors are attached at both edges of cable. The resistor reduces reflected wave at terminal point and prevents disturbance of signal. Use resistors suitable for cable used.

Method to connect: CC-Link basic connection is multi drop connection. And T-branch connection is available in case of 625kbps or less of communication speed or in case of using repeater.

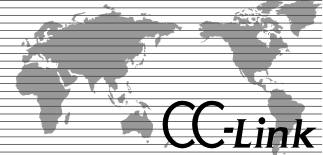

Trunk line: The cable attached terminal resistor on both edges.

Trunk line length: The cable length of inter terminal resistor without branch line length.

Branch line: The cable branched off from trunk line.
Can not branch off from branch line without repeater.

Branch line length: The cable length of 1 branch line.

Total branch line: Total length added whole branch line.

Communication speed and cable length: Refer to Section 2.2 (2) and (3).

CC-Link

Chapter 2: Construction and specifications of network system

2.2 Network specification



(1) CC-Link versions

This document describes the wiring specifications for CC-Link Ver.1.10. Refer to the Appendix for details on the CC-Link Ver.1.00 wiring specifications.

Table 2.1 CC-Link versions

Ver.1.00	—————
Ver.1.10	The station-to-station cable length increased to 20cm or more, improving wiring performance. *Device and cable specifications changed.
Ver.2.00	System and per-station data volume increased to a maximum of 8 times. *Cable specifications not changed from Ver.1.10.

Table 2.2 How to identify the CC-Link version

Version	Logo	Identification method
Ver.1.00		-
Ver.1.10		"CC-Link Ver.1.10" is described on the manuals, rating plates, catalogs, packings, and others.
Ver.2.00		"CC-Link Ver.2.00" is described on the manuals, rating plates, catalogs, packings, and others.

It is recommended that you use Ver.1.10-compatible cables for devices which are Ver.1.10 or later (Ver.1.10 and Ver.2.00). If the overall system consists of devices which are Ver.1.10 or later (Ver.1.10 and Ver.2.00) and Ver.1.10 cables, the following advantages can be obtained.

- 1) The minimum length for all connecting cables between stations is 20 cm under all conditions.(Note 1)
There is no need to take into consideration any restrictions on cable lengths as a result of differences in the type of station between neighboring devices.
(Note 1) When the station-to-station cable length is the shortest, use a 7.2 m cable for every 10 modules.
- 2) Because of the increased freedom in the lengths of the cables, the burden of wiring work and the positioning of devices can be reduced.
- 3) When devices are placed net to each other, there is no need to leave any excess length of cable, so that space can be used much more efficiently.
- 4) Cables from different manufacturers can be used together at the same time.

Note: For systems where Ver.1.00, 1.10 and 2.00-compatible units and Ver.1.00 and 1.10 cables are being used together at the same time, the maximum overall cable extensions and the length of cables connecting different stations will correspond to Ver.1.00 specifications. Refer to the appendix for details on CC-Link Ver.1.00 specifications.

(2) Multidrop connection (CC-Link Ver.1.10)

(Condition: All devices and CC-Link cable should be Ver.1.10 compatible products. If any of products is in Ver.1.00, follow the specification for Ver.1.00)

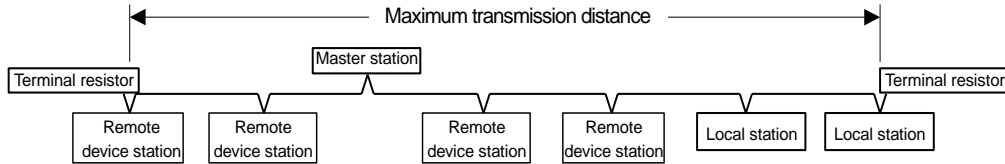

Fig. 2.1 Connection style

CC-Link dedicated cable Ver.1.10(Characteristic Impedance: 110 ohm type)

Table 2.3 Communication speed and cable length (CC-Link dedicated cable Ver.1.10)

Communication speed	156 kbps	625 kbps	2.5 Mbps	5 Mbps	10 Mbps	
Station-to-station cable length	20 cm or more	20 cm or more	20 cm or more	20 cm or more	20 cm or more	20 cm or more ^{*3}
Maximum transmission distance	1200 m	900 m	400 m	160 m	80 m ^{*1}	100 m ^{*2}

(*1) System configuration where the maximum transmission distance is 80 m or less (In this example, the minimum station-to-station cable length restriction does not apply.)

For the maximum transmission distances of the high flexible cables, refer to Tables 2.4, 2.5, and 2.6.

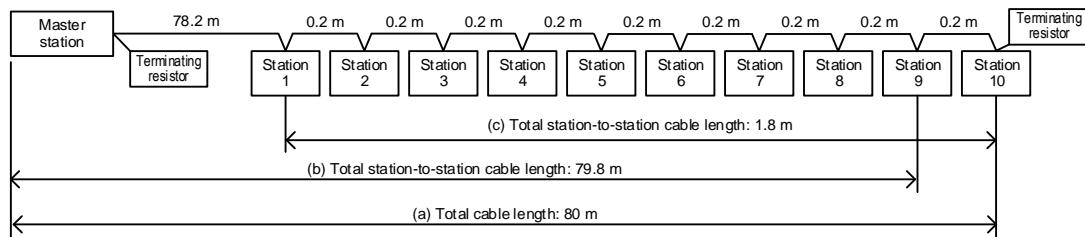

(*2) System configuration where the maximum transmission distance exceeds 80 m (In this example, the minimum station-to-station cable length restriction applies.)

For the maximum transmission distances of the high flexible cables, refer to Tables 2.4, 2.5, and 2.6.

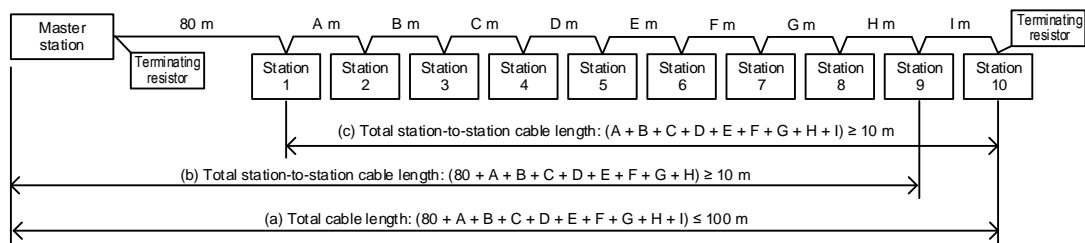

(*3) Restrictions

When the total number of connected stations including the master station is 11 or more, the total station-to-station cable length of each consecutive 10 stations should be 10 m or more. (If the total number of connected stations including the master station is less than 11, the restriction does not apply.)

CC-Link

Chapter 2: Construction and specifications of network system

CC-Link dedicated high flexible cable Ver.1.10(Characteristic Impedance: 110 ohm type)

There are the following three different cables according to the specifications of the maximum transmission distance.

- 1) Transmission distance 70% product (the cable model name is ended by "-7".)
- 2) Transmission distance 50% product (the cable model name is ended by "-5".)
- 3) Transmission distance 30% product (the cable model name is ended by "-3".)

Table 2.4 Communication speed and cable length (Ver.1.10 compatible CC-Link dedicated high flexible cable (Transmission distance 70% product))

Communication speed	156 kbps	625 kbps	2.5 Mbps	5 Mbps	10 Mbps	
Station-to-station cable length	20 cm or more	20 cm or more	20 cm or more	20 cm or more	20 cm or more	20 cm or more ³
Maximum transmission distance	840 m	630 m	280 m	112 m	56 m ¹	70 m ²

Table 2.5 Communication speed and cable length (Ver.1.10 compatible CC-Link dedicated high flexible cable (Transmission distance 50% product))

Communication speed	156 kbps	625 kbps	2.5 Mbps	5 Mbps	10 Mbps	
Station-to-station cable length	20 cm or more	20 cm or more	20 cm or more	20 cm or more	20 cm or more	20 cm or more ³
Maximum transmission distance	600 m	450 m	200 m	80 m	40 m ¹	50 m ²

Table 2.6 Communication speed and cable length (Ver.1.10 compatible CC-Link dedicated high flexible cable (Transmission distance 30% product))

Communication speed	156 kbps	625 kbps	2.5 Mbps	5 Mbps	10 Mbps	
Station-to-station cable length	20 cm or more	20 cm or more	20 cm or more	20 cm or more	20 cm or more	20 cm or more ³
Maximum transmission distance	360 m	270 m	120 m	48 m	24 m ¹	30 m ²

When using CC-Link dedicated cables and high flexible cables together

Within the following expression range, the Ver.1.10 compatible CC-Link dedicated cables and Ver.1.10 compatible CC-Link dedicated high flexible cables can be used together.

Maximum transmission distance of CC-Link dedicated cables

$$\geq (\text{CC-Link dedicated cable length}) + (\text{high flexible cable length (transmission distance 70\% product)}) / 0.7 + (\text{high flexible cable length (transmission distance 50\% product)}) / 0.5 + (\text{high flexible cable length (transmission distance 30\% product)}) / 0.3$$

- * Cables of different vendors can be used together if they are Ver.1.10 compatible.
- * The same restriction as (*3) also applies to the high flexible cables. If it is difficult to change the wiring, change the transmission speed of the system to 5 Mbps or lower, or consider using a CC-Link system repeater module.

(3) T-branch connection

1) When repeater is not used

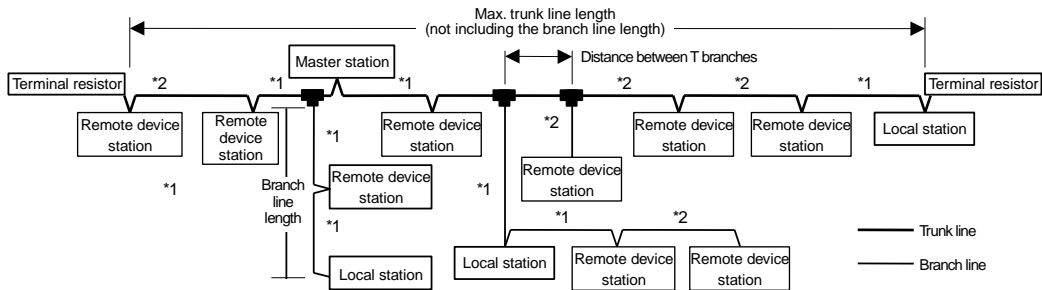

Fig. 2.5 T-branch connection (When repeater is not used)

Table 2.7 Communication speed and cable length (T-branch connection (When repeater is not used))

Communication speed		156kbps	625kbps	10M/5M/2.5Mbps are not allowed
Station-to-station cable length	Between master and local stations, intelligent device station, and adjacent stations *1	1m or more		For a system configured only with remote I/O stations and remote device stations
		2m or more		For a system configuration that contains local stations and intelligent device stations
	Between remote I/O stations and remote device stations (shortest cable) *2	30cm or more		
Max. No. of stations connected to the branch line (per branch)		6		See communication specification for the total number of connected stations
Max. trunk line length		500m	100m	The length of the cable between terminal resistors. The branch line length is not included.
Distance between T branches		No limit		
Max. branch line length		8m		Cable length per branch
Overall branch line length		200m	50m	Total length of all branch lines

Note: As the connection cable, use the Ver.1.10 compatible CC-Link dedicated cable (characteristic impedance 110Ω).

CC-Link

Chapter 2: Construction and specifications of network system

2) When repeater is used

Enable to Connect T-Branch with repeater at every communication speed.

Enable to Extend transmission distance by using some pcs of repeater.

(Note)

When a repeater is used, follow the specifications specified in Tables 2.8, 2.9, and 2.10.

Followings are product repeater specification:

Repeater(T-branch) module

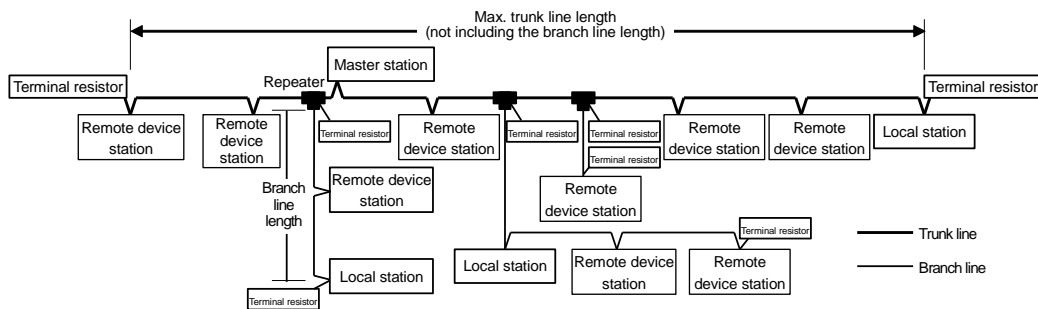
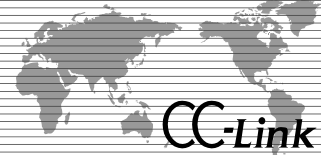

Fig 2.6 T-branch connection (When repeater is used)

Table 2.8 Communication speed and cable length (Repeater (T-branch) module)

Communication speed	156kbps	625kbps	2.5Mbps	5Mbps	10Mbps
Station to station cable length	Same as station to station cable length of CC-Link system.				
Max. No. of stations connected to the branch line (Per branch)	No limited (within No. of CC-Link specification)				
Max. trunk line length	Transmission distance of CC-Link system				
Max. branch line length	Transmission distance of CC-Link system				
Max. No. of station per each segment*	10 level				
Total transmission distance (Trunk line length + branch line length)	13200m	9900m	4400m	1760m	1100m

*:Segment means total name that CC-Link system devices from terminal resistor to terminal resistor on multi drop with using repeater.



When optical repeater module is used
SI/QSI optical fiber cable

Table 2.9 Communication speed and cable length (Optical Repeater module (SI/QSI))

Communication speed	156kbps	625kbps	2.5Mbps	5Mbps	10Mbps
Station to station cable length	Same as CC-Link specification				
Max. No. of stations connected to the branch line(per branch)	No limited(within CC-Link specification)				
Max. trunk line length	Transmission distance of CC-Link system				
Max. branch line length	Transmission distance of CC-Link system				
Between repeater max. optical fiber cable length	500m(SI optical fiber cable) 1000m(QSI optical fiber cable)				
Max. No. of stations per segment*	3 level				
Total transmission distance(QSI optical cable)	7800m	6600m	4600m	3640m	3400m

*: Segment means total name that CC-Link system devices from terminal resistor to terminal resistor on multi drop with using repeater.

GI optical fiber cable

Table 2.10 Communication speed and cable length(Optical repeater module (GI))

Communication speed	156kbps	625kbps	2.5Mbps	5Mbps	10Mbps
Station to station cable length	Same as CC-Link specification				
Max. No. of stations connected to the branch line(per branch)	No limited(within CC-Link specification)				
Max. trunk line length	Transmission distance of CC-Link system				
Max. branch line length	Transmission distance of CC-Link system				
Between repeater max. optical fiber cable length	2000m				
Max. No. of stations per segment*	2 level				
Total transmission distance(QSI optical cable)	7600m	6700m	5200m	4480m	4300m

*:Segment means total name that CC-Link system devices from terminal resistor to terminal resistor on multi drop with using repeater.



Chapter 3: Select guide for connected devices

3.1 CC-Link Cable

CC-Link dedicated cable shall be used in CC-Link system.

Specification of CC-Link dedicated cable is as following:

Table 3.1 Specification of CC-Link dedicated cable(Ver.1.10)

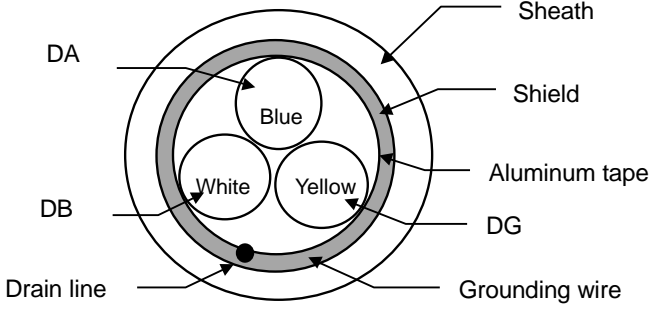
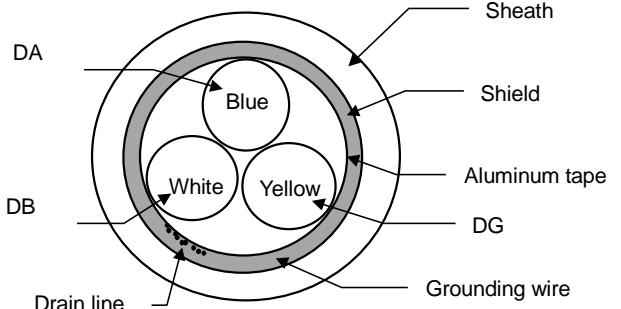
Item		Specifications	
Cable type		Shielded twisted cable	
Finish outer diameter		8.0 mm or less	
Number of wire cores		3	
Conductor size		20AWG	
Isolator standard thickness		0.55 to 0.80 mm	
Drain line		20 lines/0.18 mm or 24 lines/0.18 mm Insert separately or in a bundle between the ground cable bundle and aluminum tape.	
Electric characteristics	Conductor resistance (20°C)	37.8Ω/km	
	Insulation resistance	10000 MΩ km or more	
	Withstand voltage	500VDC 1 minute	
	Electrostatic capacity (1kHz)	60 nF/km or less	
	Characteristic impedance	1MHz	110±15Ω
		5MHz	110±6Ω
Attenuation amount (20°C)	1MHz	1.6 dB/100m or less	
	5MHz	3.5 dB/100m or less	
Cross section			
			

Connection with device

Table 3.2 The color of isolator and terminal connector

Color of isolator	Terminal
Blue	DA
White	DB
Yellow	DG
Grounding wire(Shield)	SLD



Chapter 3: Select guide for connected devices

3.2 Terminal resistor

The termination resistors which can be used with Ver.1.10-compatible CC-Link dedicated cables are $110\Omega \pm 5\%$ 1/2W.

3.3 Connector

Following are the recommended specifications for cable relay connectors and circuit board mounting connectors and cable linking connectors which can be used with CC-Link.

(1) IP20 connector types (5-pin)

Table 3.3 Specifications for IP20 connector types (5-pin)

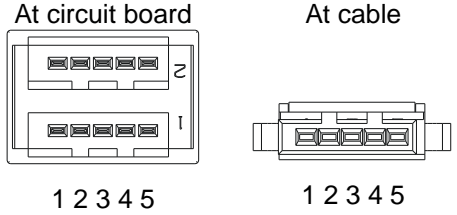
	Connector type	Contact
Contact resistance	30mΩ or less	CLPA
Metal plating thickness	0.2μm or more	<p>Pin layout</p> <p>At circuit board At cable</p> 
Waterproofing type	IP20 (JIS C 0920)	
Pin layout	1pin:DA 2pin:DB 3pin:DG 4pin:OPEN 5pin:SLD	

Note: Use connectors which have been approved by CLPA for both male and female connectors.

(2) M12(Micro) type (4 cores) – A coding

Table 3.4 Specification of M12(Micro) type (4 cores)

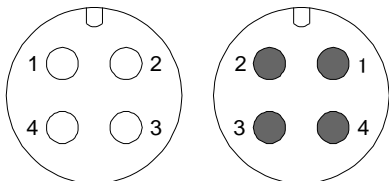
	M12(Micro)type	Contact
Contact resistance	5mΩ or less	CLPA
Thickness of gold plate	0.1μm or more	<p>Pin position</p> <p>Female Male</p> 
Type of water proof	IP67(JIS C 0920)	
Pin position	1pin:SLD 2pin:DB 3pin:DG 4pin:DA	

Note: If use cordset(cable with connectors), use one certified by CLPA.

Recommended specifications of connector relaying between CC-Link dedicated cables are as followings:

(3) Easy connection water proof type(4 cores, 7 cores)

Table 3.5 Easy connection water proof type

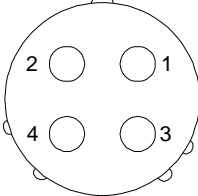
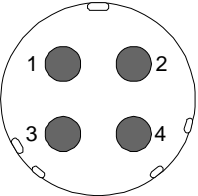
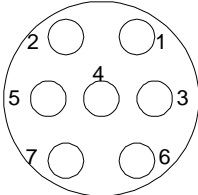
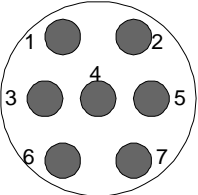
	Easy connection water proof type	<u>Contact</u>	
Contact resistance	5mΩ or less	CLPA	
Thickness of gold plate	0.5μm or more		
Type of Water proof	IP67 (JIS C 0920)		
Conducts	Pin position		
4 conductors	1pin:DA 2pin:DB 3pin:DG 4pin:SLD	Female	Male
			
7 conductors (with power conductor)	1pin:DA 2pin:DB 3pin:DG 4pin:N.C. 5pin:+24V 6pin:24G 7pin:SLD	Female	Male
			

Note: It can be used for connection from control panel to out side.

Contact partner vendors which described on CC-Link products catalog published by CLPA or CLPA web site (<http://www.cc-link.org/>)

Following are the recommended connection conditions for CC-Link cable relay connectors.

Table 3.6 Recommended connection conditions for cable relay connectors

Communication speed		156kbps	625kbps	Notes
Length of cable between stations	Stations before and after master/local stations and intelligent device stations	1m or more		For system configurations between remote I/O and remote device stations only
		2m or more		For system configurations which include local stations and intelligent device stations
	Between remote I/O stations and remote device stations (shortest cables)	30cm or more		—
Max. transmission distance		500m	100m	—
Relay connector interval		No limit		—

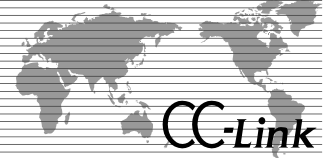

3.4 Power supply

Connect a power supply that meets the input power supply specifications of each device manufacturer.

Chapter 4: Set up and cable wiring

4.1 Points to keep in mind to set up cable wiring

(1) Communication speed/ Maximum transmission distance

Maximum transmission distance depends on communication speed and/or kinds of CC-Link dedicated cable.

Connect and set up according to Chapter 2 “2.2 Network specification”

(2) Minimum radius of bending cable

Keep Minimum radius of bending cable in using CC-Link dedicated cable

It may cause pulling out from connector and cable, breaking of cable, and so on, when CC-Link dedicated cable is used with less than minimum radius.

Minimum radius of bending cable	Connecting	major diameter of cable x 10 or more
	Stable	major diameter of cable x 4 or more

Minimum radius of bending cable at connecting is permitted in only connecting.

Minimum radius of bending cable at stable permits the characteristic for long period.

(3) Permissible tension

Do not add tension to cable as much as possible.

If it was pulled strong, it may cause pulling out connector and cable, breaking of cable , possibility of not keeping the characteristic and so on.

At Connecting: If you have no choice but to tension, use within permissible tension.

At Stable: Take notice cable length, how to fix not to add tension to the cable.

Permissible tension(N)=68.6(Unit permissible tension of conductor N/mm²)x(No. of cable cores)x(sectional area of conductor)

(Presented by communication cable expert committee of The Japanese Electric Wire & Cable Makers' Association

“Investment Vol. 117, How to select and use communication cable”

4.2 Section in Chapter 4 Permissible tension of cable (published in April of 1994))

CC-Link

Chapter 4: Set up and cable wiring

(4) Points to keep in mind against noise

In order to prevent induced noise, keep signal line as far away from power line as possible.

(We recommend to wire keeping away 100mm or more)

Not set cable up on control panel where high voltage devices are mounted.

Attach surge absorber on devices which radiate noise.

(5) Relay connectors for CC-Link cables

If making relay connections using components such as relay terminal boards and relay connectors when laying out CC-Link cables, communication errors may occur for some systems, and so it is recommended that the cables be connected directly to each CC-Link unit. Alternatively, investigate whether a CC-Link repeater unit can be used.

(6) Connection with moving point

Use CC-Link dedicated high flexible cable in case of connecting with moving point.

And take notice the followings in order to prevent cable from being broken early.

- Not scratch cable coat.
- Not connect cable with wound.
- Minimize fixed point to set cable
- Not to force to fix cable at point where cable moves
- Connect cable as most suitable length.
- Secure area for radius of bending cable ten times or more cable outer diameter.

(7) Others

- Connect cable during power suppliers of connected devices and communication are in off state.
- Take care not to twist cable in release cable from drum or wound.
- Keep cable electrically and mechanically as far away from other cable (power cable, etc) as possible,

4.2 Process and connection of CC-Link dedicated cable (In case of terminal)

Process CC-Link dedicated cable according to the table 4.1. As well, refer to the table 4.1 for the length of removed cable coat, the length of removed signal wire coat and terminal process of signal wire.

Table 4.1 How to process cable

The length of removed cable coat	The length of removed signal wire coat.	Terminal process of signal wire
50mm	3mm	Pressure terminal

1) Removing cable coat

Remove CC-Link dedicated cable coat not to scratch shield mesh. But not remove extra amounts not to cause short.

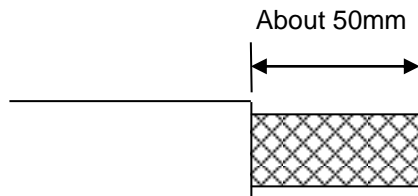

Fig. 4.1 Removed cable coat

2) Process shield

Ravel shield mesh carefully. As well as signal wire, there is one bare drain wire (stranded wire or each wire). Process the shield according to any of followings.

(1) When shield mesh is used

Coat with isolation tube after putting tightly shield mesh and drain wire together.

(2) When drain wire is used

Coat drain wire with isolation tube after trimming off the excess shield mesh.

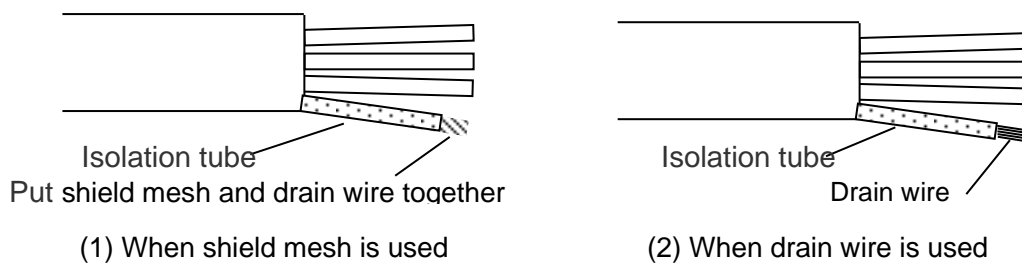

Fig. 4.2 Process shield

Glink

Chapter 4: Set up and cable wiring

3) Remove signal wire coat
 Remove coat of signal wire according to size of Pressure terminal. Put tightly bear signal wire together.

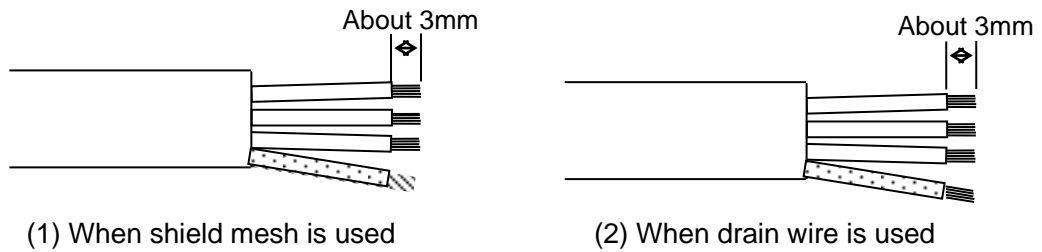

Fig. 4.3 Remove signal wire coat

4) Connection pressure terminal
 Connect signal wire removed coat, shield wire with pressure terminal differently.

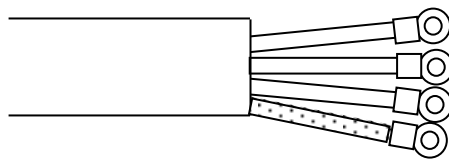

Fig. 4.4 Connection pressure terminal

5) Connection terminal

Connect signal wire attached pressure terminal with each terminal then drive a screw in tightly.
 Refer to the table 4.2 as to name of terminal and color of cable conductor

Table 4.2 Name of terminal and color of cable conductor

Terminal	Signal conductor
DA	Blue
DB	White
DG	Yellow
SLD	Ground(shield)

4.3 Terminal resistor connection

Connect “terminal resistor (110Ω)” enclosed at both edges.

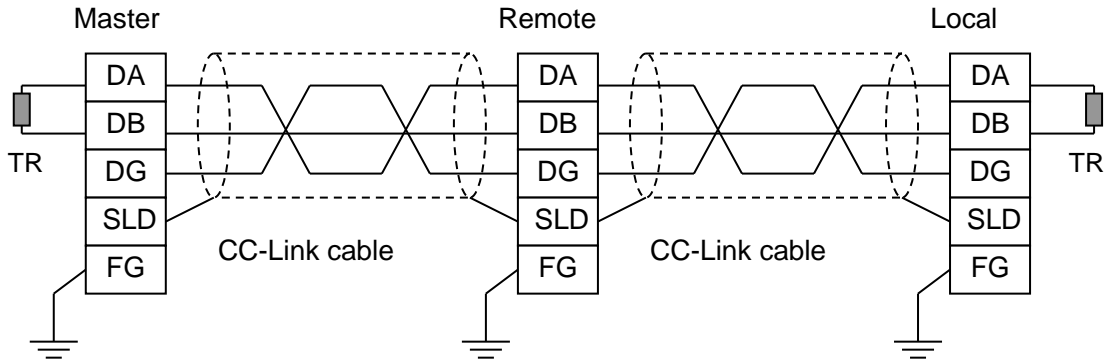

Fig. 4.5 Connection of terminal resistor

T-Branch connection

- (1) When repeater is not used
Connect terminal resistor ($110\Omega \pm 5\%$ 1/2W) between DA and DB on each edge of trunk line.
(Not use CC-Link dedicated high performance cable)
- (2) When repeater is used
Use “Terminal resistor” included in Repeater module.

4.4 Connection of shield line with ground

- Connect both edges of shield wire for CC-Link dedicated cable with "SLD" of each module.
- Connect "FG" of each module independently.
- Always ground the FG terminals to the protective ground conductor. (Ground resistance: 100 ohm or less)
- If not use ground independently, use common ground according to the Fig. 4.6.
- "SLD" and "FG" of each module are connected together inside of the module.
- Refer to Fig. 4.5 on the previous page for how to connect ground.

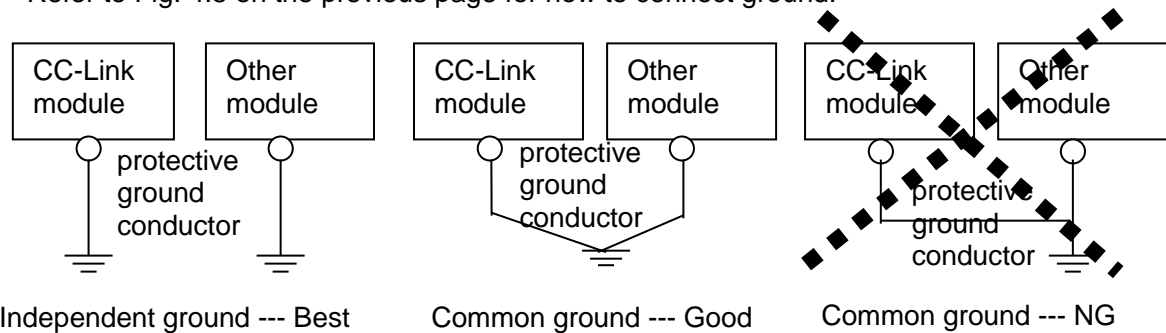

4.4.1 Supplementary explanation on grounding

(1) Grounding types

1. Protective grounding to protect human bodies from electric shocks and ground faults
2. Functional grounding to ensure communication reliability

The grounding of the shield wire of the CC-Link dedicated cable is functional grounding to ensure communication reliability.

Indication of
protective grounding
terminal



Indication of
functional grounding
terminal



(2) Supplements to grounding methods

For protective grounding or functional grounding, use independent grounding (Fig. 4.6) or common grounding where cables are wired individually up to the grounding point (Fig. 4.7).

In the case of common grounding (Fig. 4.8), noise may enter the functional grounding from the protective grounding, making CC-Link communication instable. Especially when common grounding is used for the protective grounding and functional grounding (shield wire of CC-Link dedicated cable) of drive devices such as inverter and servo, the possibility of instable communication will increase.

- 1) As the ground wire of the functional grounding, use a copper wire of 1.6mm or more diameter or 2mm² or more.

(As the ground wire up to the grounding point, it is recommended to use the thickest possible copper wire (14mm² or more recommended) at a short distance.)

- 2) Do not tie the ground wire of the functional grounding together with the protective grounding wire, power cable, etc. (Noise may enter the ground wire, making communication instable.)

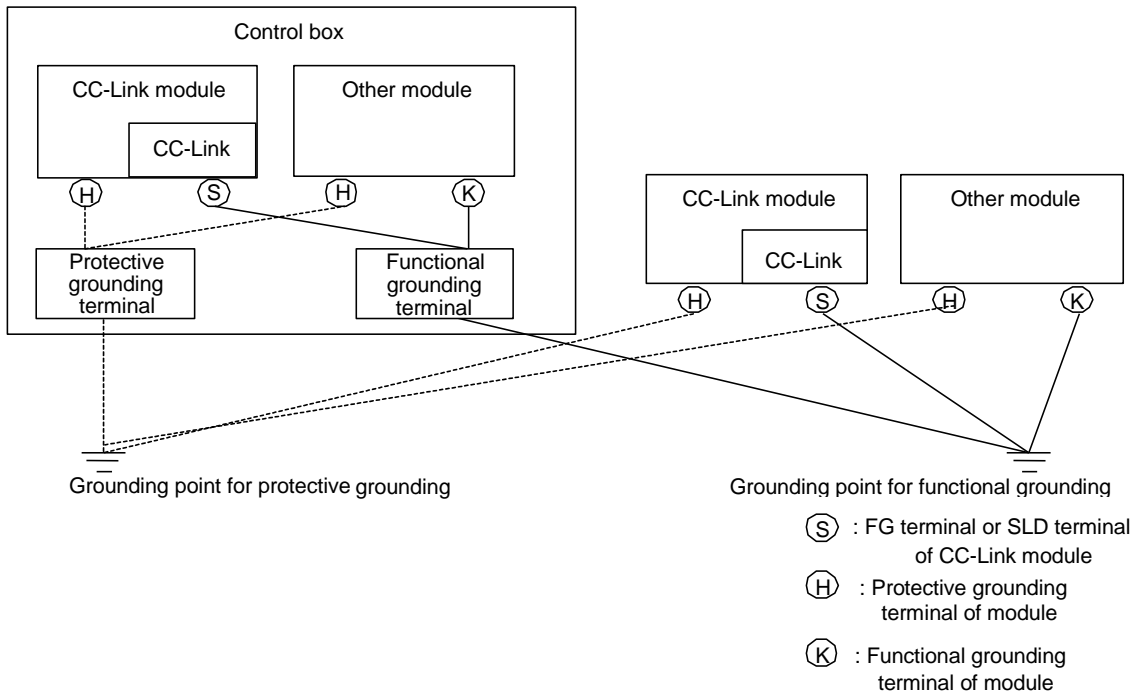

Fig. 4.6 Independent grounding example

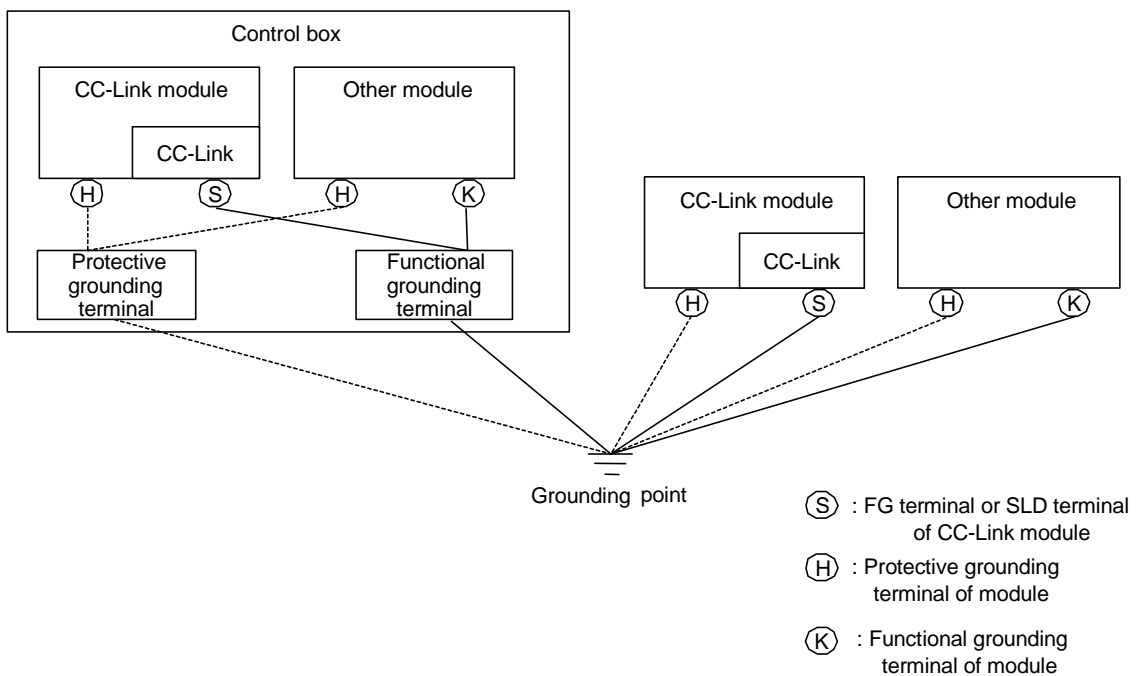

Fig. 4.7 Common grounding example

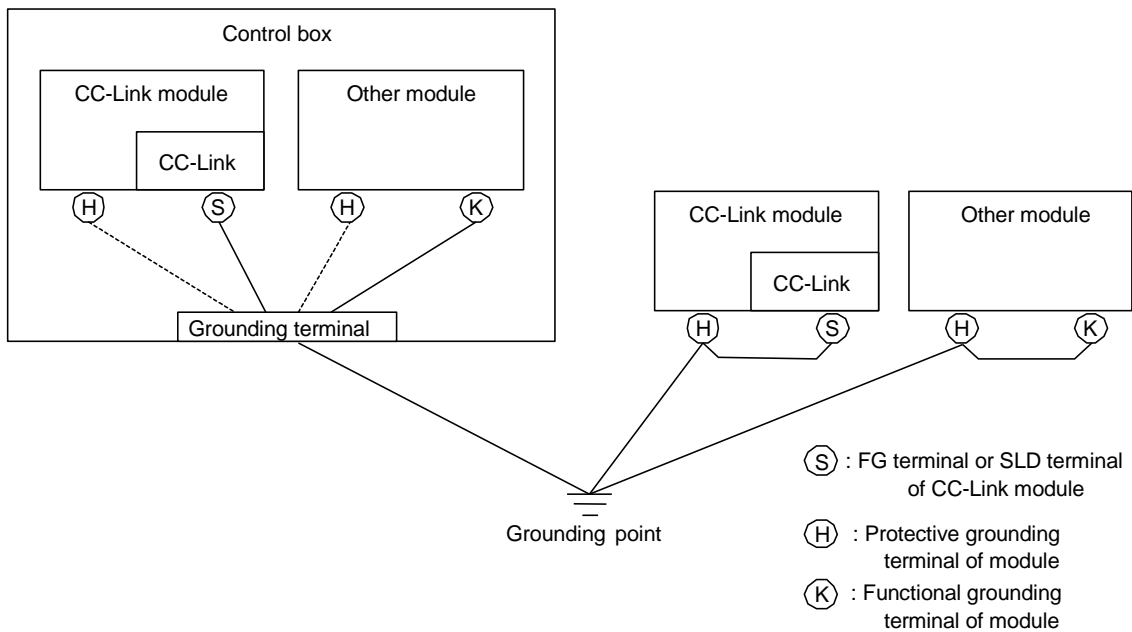
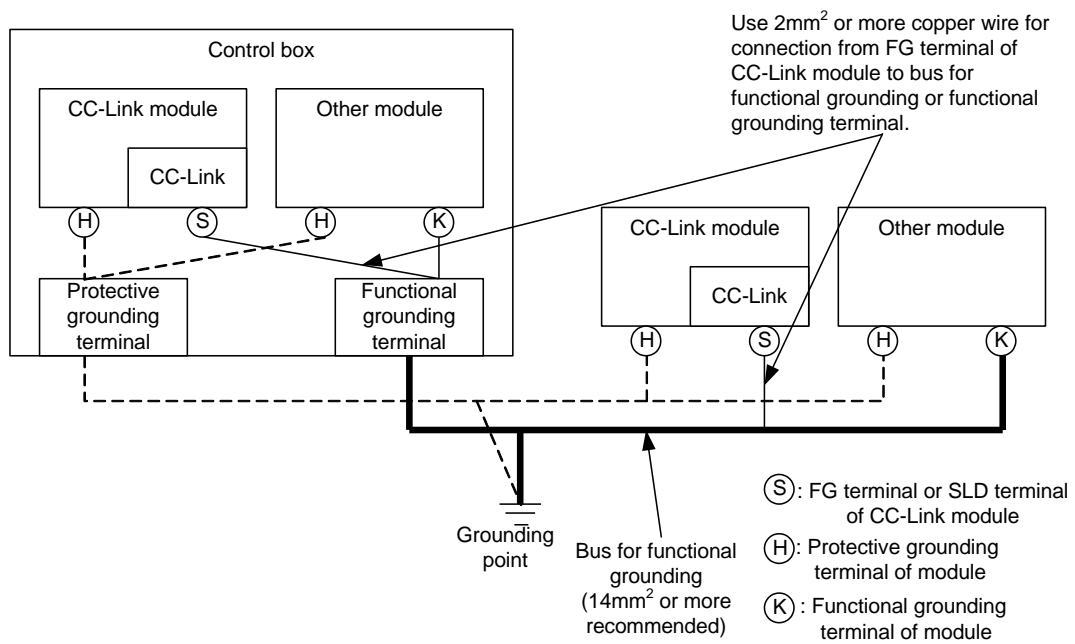
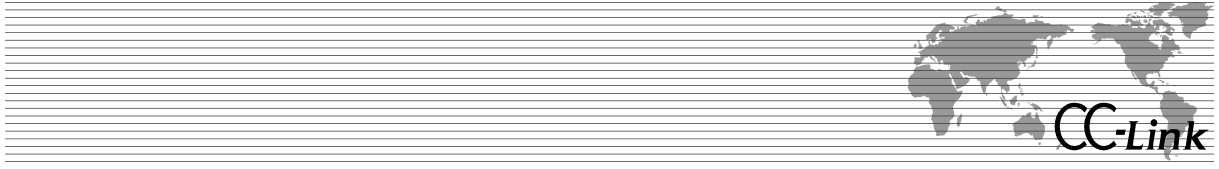

Fig. 4.8 Common grounding example

(3) Wiring example of common grounding

The following shows the wiring example of common grounding.





Appendix CC-Link Ver.1.00 Specifications

CC-Link

Appendix CC-Link Ver.1.00 Specifications

(1) Communication speed and cable length:

(If any of devices or cables is in Ver.1.00, follow the specification for Ver.1.00)

<System configured with only Remote I/O station and /or Remote device>

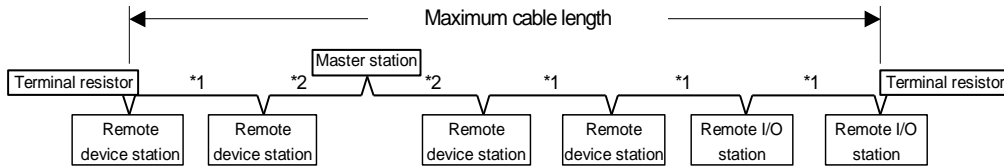

*1: Cable length between Remote I/O, Remote device and Remote I/O, Remote device.
 *2: Cable length between Master and next station.

Fig. 5.1 In case of system configured with only Remote I/O station and/or Remote device station

<System including Local station and/ or Intelligent device station >

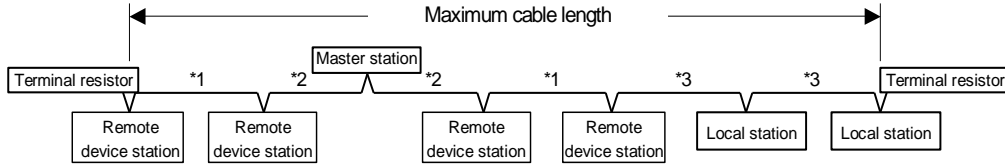

*1: Cable length between Remote I/O, Remote device and Remote I/O, Remote device.
 *2: Cable length between Master and next station.
 *3: Cable length between Local, Intelligent device and next station.

Fig. 5.2 In case of system including Local and/ or Intelligent device

Ver.1.00 compatible CC-Link dedicated cable(Characteristic Impedance: 100 ohm type)

Table 5.1 Communication speed and cable length(CC-Link dedicated cable)

Communication speed		156kbps	625kbps	2.5Mbps	5Mbps	10Mbps				
Station to station Cable length	Between Master/Local, Intelligent device station and adjacent stations ^{*2, *3}	1m or more								
	Between Remote I/O, Remote device stations and Remote I/O, Remote device stations(shortest cable) ^{*1}	30cm or more	30cm or more	30cm or more	60cm or more	30 - 59cm	1m or more	60 - 99cm	30 - 59cm	
Max. transmission distance		1200m	600m	200m	150m	110m	100m	80m	50m	

*:Upper line includes only Remote I/O, Remote device station. Lower line includes Local, Intelligent device station.

Ver.1.00 compatible CC-Link dedicated high-performance cable(Characteristic Impedance: 130 ohm type)

Table 5.2 Communication speed and cable length(CC-Link dedicated high performance cable)

Communication speed		156kbps	625kbps	2.5Mbps	5Mbps	10Mbps							
Station to station Cable length	Between Master/Local, Intelligent device station and adjacent stations ^{*2, *3}	1m or more											
	Between Remote I/O, remote device and Remote I/O, remote device(Shortest cable) ^{*1}	30cm or more	30cm or more	30cm or more	60cm or more	30cm or more	1.0m or more	70cm or more	40 - 69cm	30 - 39cm	40cm or more	30 - 39cm	30cm or more
Max. No. of remote stations		64	64	64	64	64					48	32	
Max. transmission distance*		1,200m	900m	400m	-	160m	-	100m	30m	20m	100m	80m	100m
		1,200m	600m	200m	150m	110m	80m	50m	-	-	-	-	-

*:Upper line includes only Remote I/O, Remote device station. Lower line includes Local, Intelligent device station.

Note: Only single vendor use in case of Ver.1.00 cable

(2) T-branch connections

Use the Ver.1.00-compatible CC-Link dedicated cables, and do not use the high-performance Ver.1.00-compatible CC-Link dedicated cables.

Use termination resistors of 110Ω.

For other T-branch connection specifications, refer to “(2) T-branch connection” in “Chapter 2: Construction and specifications of network system”.

(3) Termination resistors

Following are the specifications for the termination resistors which can be used with Ver.1.00-compatible CC-Link dedicated cables.

For details on connecting termination resistors, refer to “4.3 Connection of terminal resistors”.

Table 5.3 Specification of terminal resistor

Cable	Terminal resistor
Ver.1.00 compatible CC-Link dedicated cable	110 ohm±5% 1/2W
Ver.1.00 compatible CC-Link dedicated high-performance cable	130 ohm±5% 1/2W

(4) Compatibility when expanding or repairing an existing CC-Link system (Ver.1.00)

- For systems using Ver.1.00-compatible CC-Link dedicated cables (characteristic impedance 100Ω)

Use cables from the same manufacturer and the same model as the existing sections of the system in the sections of the system which are being expanded or repaired, or alternatively use one of the following methods.

- 1) Use the same Ver.1.10-compatible CC-Link dedicated cables as used in the existing section to carry out expansion and repairs.

(Note 1) The maximum cable extension length and the length between different stations follow the specifications for Ver.1.00.

(Note 2) If cables from a different manufacturer or of a different model to the existing sections are used when carrying out expansion or repairs, insert CC-Link repeater units at the locations where the different cables are being used.

- 2) Rebuild the entire system, including existing sections, using Ver.1.10-compatible CC-Link dedicated cables.

- For systems using Ver.1.00-compatible CC-Link dedicated high-performance cables (characteristic impedance 130Ω)

Use cables from the same manufacturer and the same model as the existing sections of the system in the sections of the system which are being expanded or repaired, or alternatively use one of the following methods.

- 1) Use the Ver.1.10-compatible CC-Link dedicated cables in the sections being expanded or repaired.

(Note) Insert CC-Link repeater units at the locations where Ver.1.00-compatible CC-Link dedicated high-performance cables and Ver.1.10-compatible CC-Link dedicated cables are being connected together.



Appendix CC-Link Ver.1.00 Specifications

- 2) Rebuild the entire system, including existing sections, using Ver.1.10-compatible CC-Link dedicated cables. (Change the termination resistors from 130Ω to 110Ω.)
- 3) If there are any areas of uncertainty, contact CC-Link Partner Association using the contact details given at the end of this booklet.

Access point

CC-Link Partner Association (CLPA)

6F Ozone-front Building, 3-15-58, Ozone,
Kita-ku, Nagoya, Aichi 462-0825, Japan

TEL :+81-52-919-1588

FAX :+81-52-916-8655

URL :<http://www.cc-link.org/>

E-Mail :info@cc-link.org

All rights reserved

